

YAMAHA KX-300/U *RS*

Natural Sound Stereo Cassette Deck

Platine à cassette stéréo de la série "Natural Sound"

CENTER

OWNER'S MANUAL
MODE D'EMPLOI

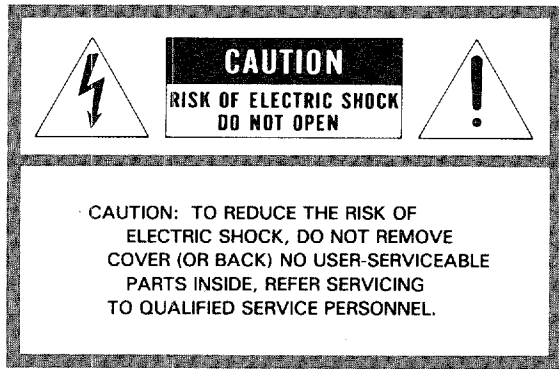

IMPORTANT

Please record the serial number of your unit in the space below.

Model: **KX-300U**

Serial No;

The serial number is located on the rear of the unit. Retain this Owner's Manual in a safe place for future reference.

• Explanation of Graphical Symbols

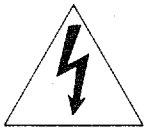

The lightning flash with arrowhead symbol, within an equilateral triangle, is intended to alert you to the presence of uninsulated "dangerous voltage" within the product's enclosure that may be of sufficient magnitude to constitute a risk of electric shock to persons.

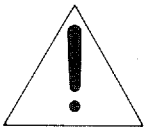

The exclamation point within an equilateral triangle is intended to alert you to the presence of important operating and maintenance (servicing) instructions in the literature accompanying the appliance.

WARNING

To prevent fire or shock hazard, do not expose this appliance to rain or moisture.

SAFETY INSTRUCTIONS

- 1** Read Instructions — All the safety and operating instructions should be read before the appliance is operated.
- 2** Retain Instructions — The safety and operating instructions should be retained for future reference.
- 3** Heed Warnings — All warnings on the appliance and in the operating instructions should be adhered to.
- 4** Follow Instructions — All operating and other instructions should be followed.
- 5** Water and Moisture — The appliance should not be used near water — for example, near a bathtub, washbowl, kitchen sink, laundry tub, in a wet basement, or near swimming pool, etc.
- 6** Carts and Stands — The appliance should be used only with a cart or stand that is recommended by the manufacturer.
- 7** Wall or Ceiling Mounting — The appliance should be mounted to a wall or ceiling only as recommended by the manufacturer.
- 8** Ventilation — The appliance should be situated so that its location or position does not interfere with its proper ventilation. For example, the appliance should not be situated on a bed, sofa, rug or similar surfaced that may block the

ventilation openings: or placed in a built-in installation, such as a bookcase or cabinet that may impede the flow of air through the ventilation openings.

- 9** Heat — The appliance should be situated away from heat sources such as radiators, stoves, or other appliances that produce heat.
- 10** Power Sources — The appliance should be connected to a power supply only of the type described in the operating instructions or as marked on the appliance.
- 11** Power-Cord Protection — Power-supply cords should be routed so that they are not likely to be walked on or pinched by items placed upon or against them, paying receptacles, and the point where they exit from the appliance.
- 12** Cleaning — The appliance should be cleaned only as recommended by the manufacturer.
- 13** Nonuse Periods — The power cord of the appliance should be unplugged from the outlet when left unused for a long period of time.
- 14** Object and Liquid Entry — Care should be taken so that objects do not fall into and liquids not spilled into the insided of the appliance.

15 Damage Requiring Service — The appliance should be serviced by qualified service personnel when:

- A. The power-supply cord or the plug has been damaged; or
- B. Objects have fallen, or liquid has been spilled into the appliance; or
- C. The appliance has been exposed to rain; or
- D. The appliance does not appear to operate normally or exhibits a marked change in performance; or
- E. The appliance has been dropped, or the cabinet damaged.

16 Servicing — The user should not attempt to service the appliance beyond those means described in the operating instructions. All other servicing should be referred to qualified service personnel.

**1 FRONT PANEL
PANNEAU AVANT**

**U.S.A. model
Modèle pour les Etats-Unis**

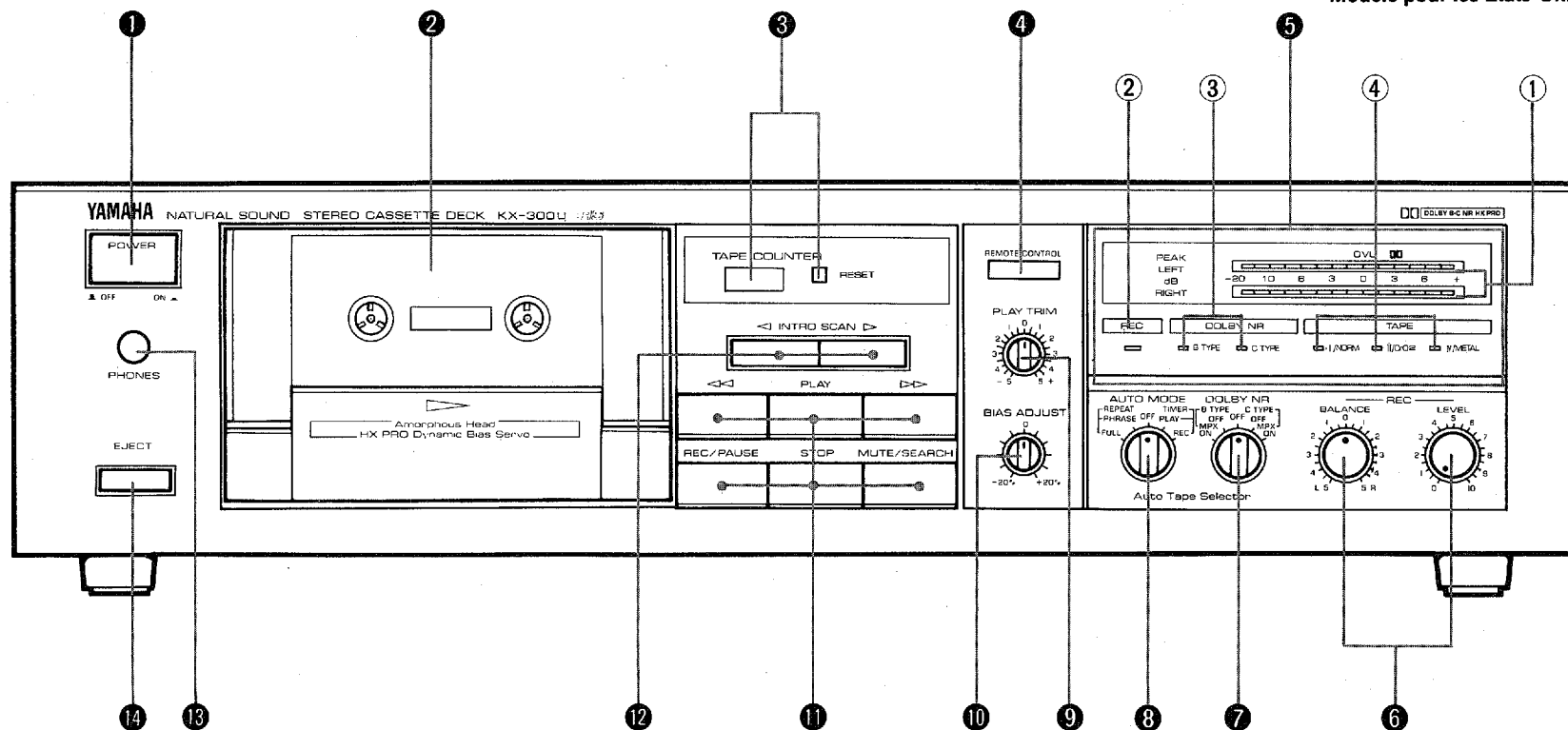

**2 REMOTE CONTROL TRANSMITTER
EMETTEUR DE TELECOMMANDE**

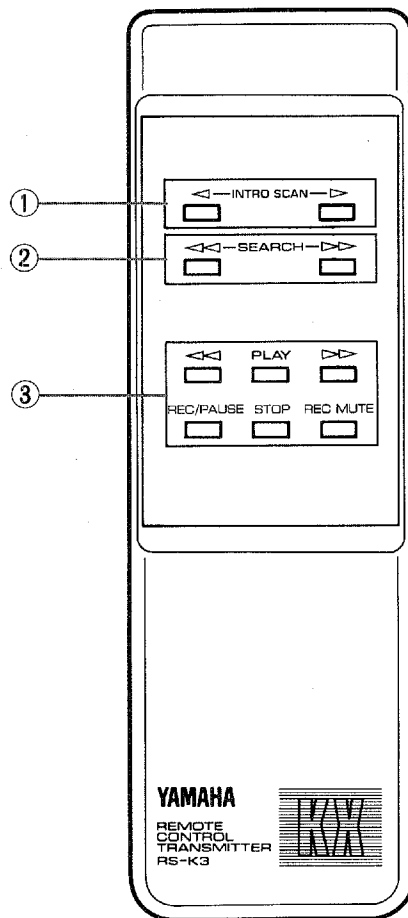

**3 BATTERY INSTALLATION
INSTALLATION DES PILES**

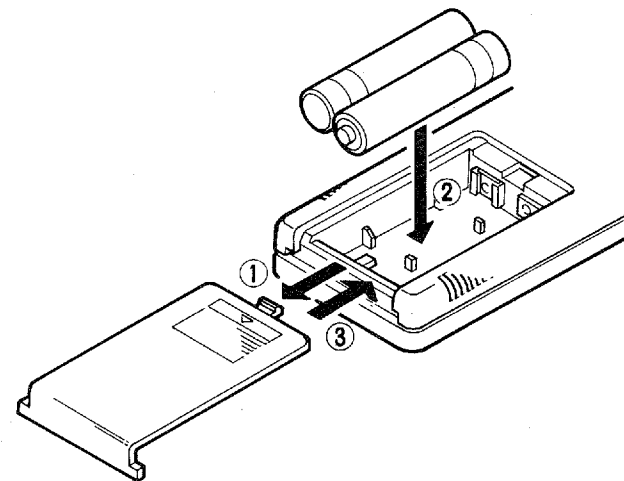

**4 REMOTE CONTROL OPERATION RANGE
GAMME DE FONCTIONNEMENT DE LA
TELECOMMANDE**

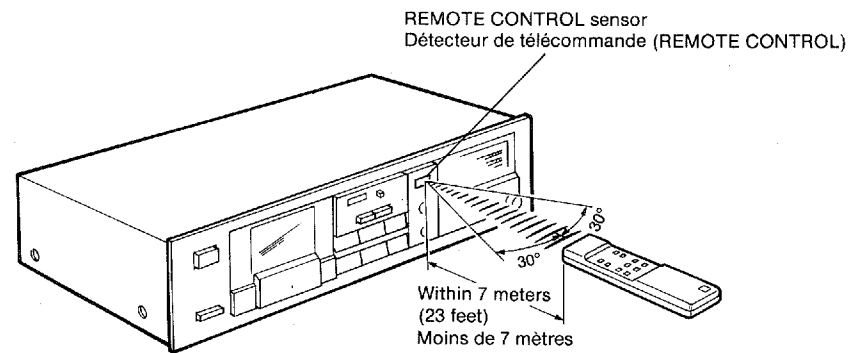

**5 DOLBY NOISE REDUCTION
REDUCTION DE BRUIT DOLBY**

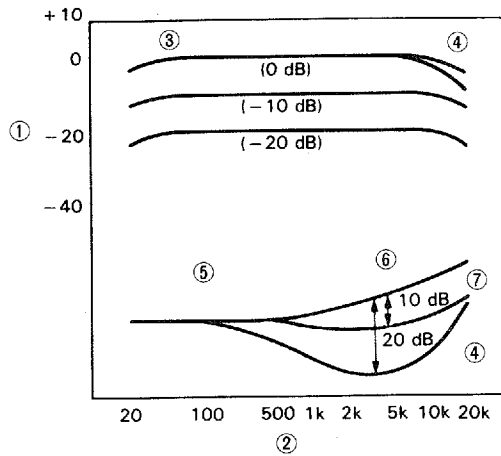

- ① Level (dB)
Niveau (dB)
- ② Frequency (Hz)
Fréquence (Hz)
- ③ Frequency response
Réponse en fréquence
- ④ C TYPE
Type C
- ⑤ Noise reduction effect
Effet de la réduction de bruit
- ⑥ DOLBY NR OFF
DOLBY NR A L'ARRET
- ⑦ B TYPE
TYPE B

**6 PLAY TRIM
REGLAGE DE LECTURE**

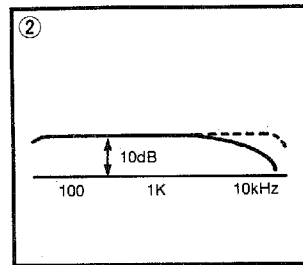
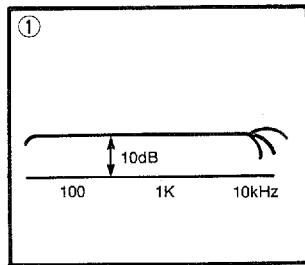

(... compensated with
the PLAY TRIM control)
(... compensé avec la
commande PLAY TRIM)

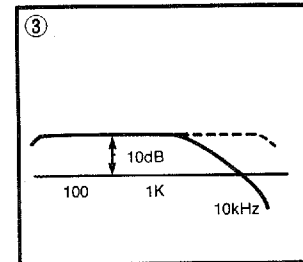

(... compensated with
the PLAY TRIM control)
(... compensé avec la
commande PLAY TRIM)

7 BIAS SETTINGS REGLAGES DE LA POLARISATION

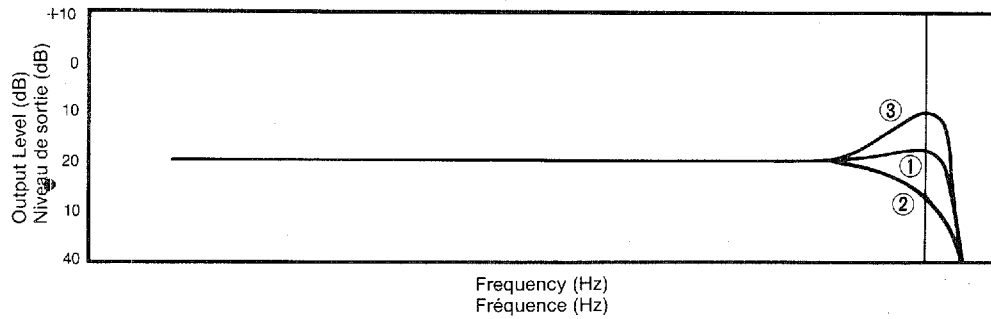

- ① Optimum bias setting
Flat frequency response, normal sound quality
Réglage de polarisation optima
Réponse en fréquence uniforme, qualité sonore normale
- ② Excessive bias (Over bias)
Too little or no high frequency sound
Turn BIAS ADJUST counterclockwise
Polarisation excessive (sur-polarisation)
Trop peu ou pas de son de haute fréquence
Tourner BIAS ADJUST dans le sens contraire
des aiguilles d'une montre
- ③ Insufficient bias (Under bias)
Emphasized of high frequency sound
Turn bias adjust clockwise
Polarisation insuffisante (sous-polarisation)
Son de haute fréquence mis en valeur
Tourner BIAS ADJUST dans le sens des aiguilles
d'une montre

8 HX PRO

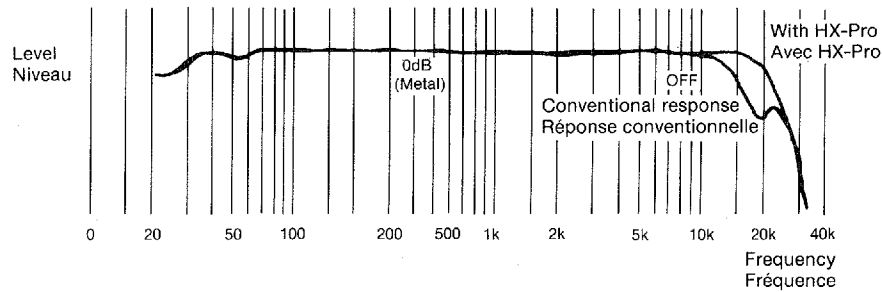

9 REAR PANEL AND CONNECTIONS
PANNEAU ARRIERE ET CONNEXIONS

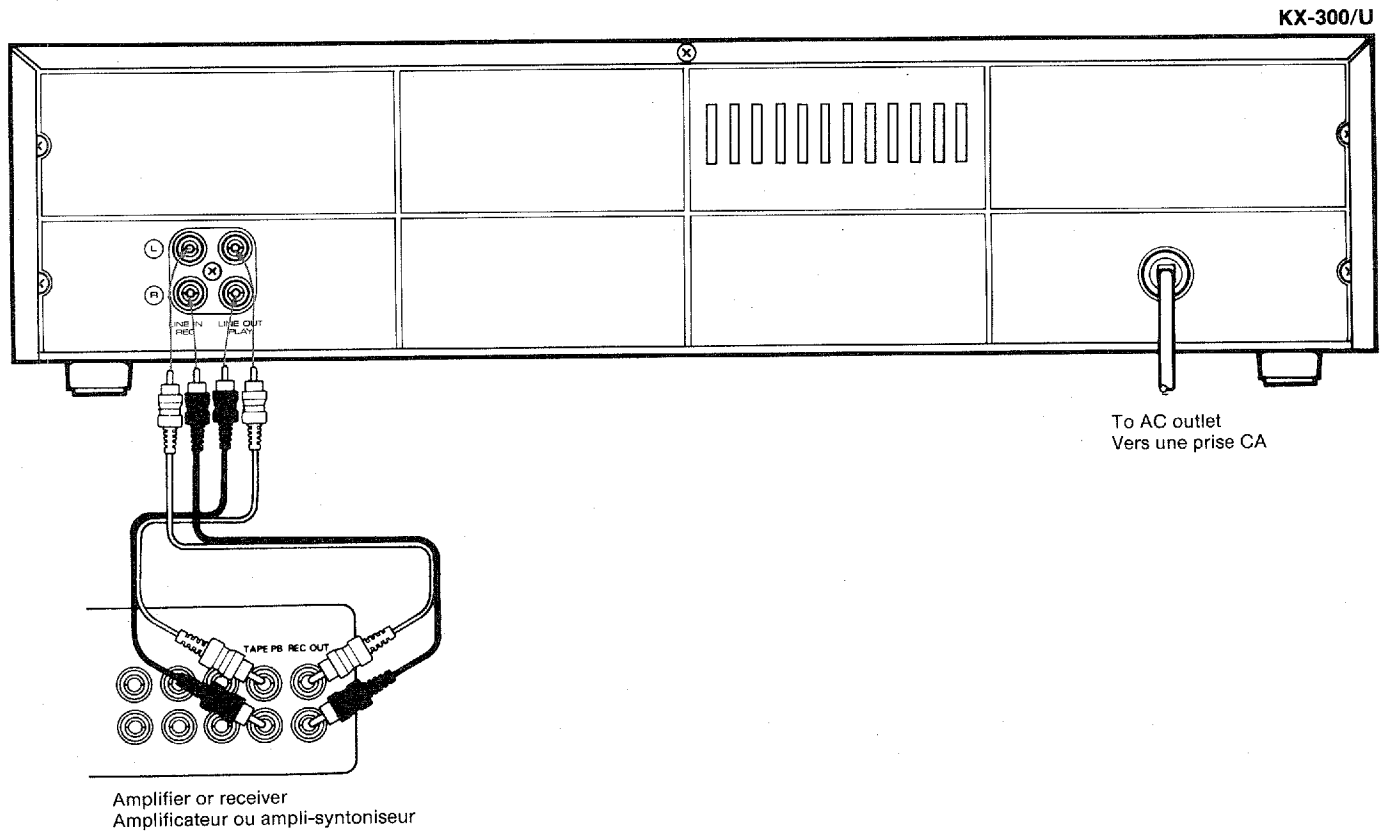

**10 RECORDING PROTECTION
PROTECTION CONTRE L'ENREGISTREMENT**

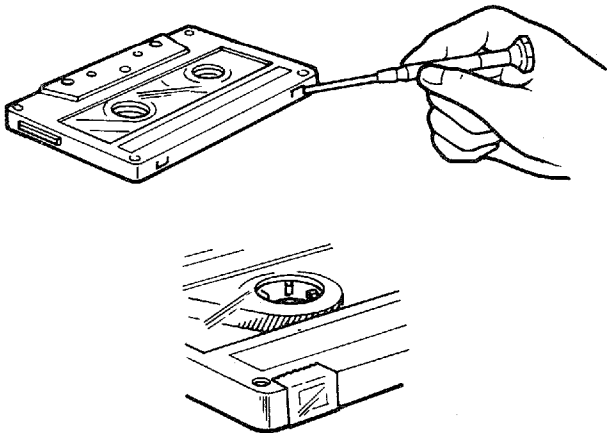

**12 TAPE SLACK
RELACHEMENT DE LA BANDE**

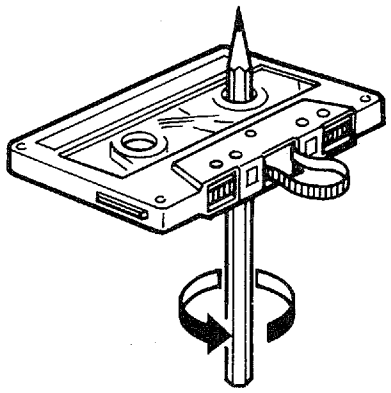

**11 DETECTOR SLOTS
TROUS DE DETECTION**

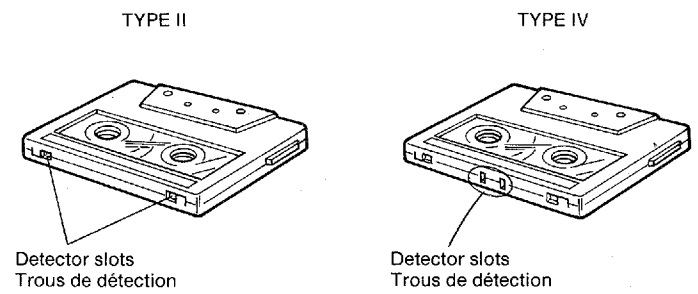

**13 TIMER CONNECTION
CONNEXION DE LA MINUTERIE**

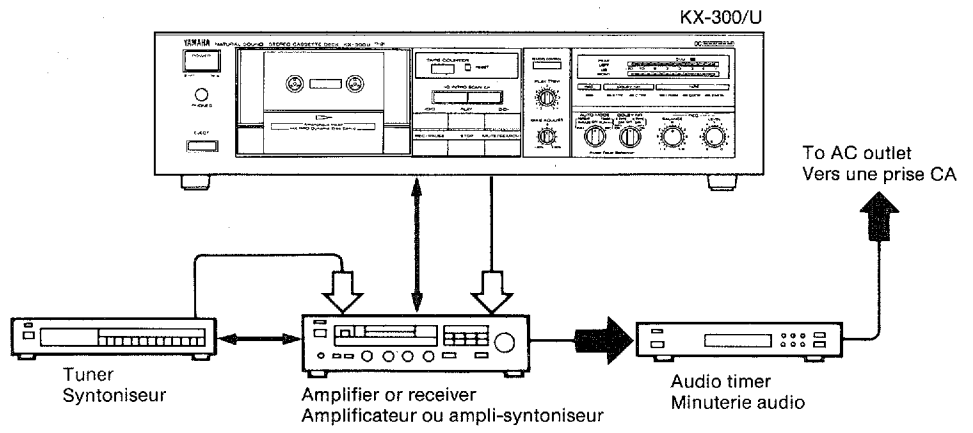

- Thank you for purchasing the YAMAHA KX-300/U stereo cassette deck.

CAUTION: READ THIS BEFORE OPERATING YOUR UNIT.

- 1.** This unit is a sophisticated stereo cassette deck. To ensure proper operation for the best possible performance, please read this manual carefully.
- 2.** Choose the installation of your unit carefully. Avoid placing it in direct sunlight or close to source of heat. Also avoid locations subject to vibration and excessive dust, heat, cold or moisture. Keep it away from such sources of hum as transformers or motors.
- 3.** Do not open the cabinet as this may result in damage to the deck or electrical shock. If a foreign object should get into the deck, contact your local dealer.
- 4.** When removing the power plug from the wall outlet, always pull directly on the plug; never pull the cord itself.
- 5.** Do not use force when operating switches and knobs.
- 6.** When moving the deck, be sure to first pull out the power plug and remove all cords connecting the deck to other equipment.
- 7.** Do not attempt to clean this unit with chemical solvents as this may damage the finish. Use a clean, dry cloth.

8. Never allow metallic items (e.g. screwdrivers, tools, etc.) to come near the record/playback head assembly. Doing so may not only scratch or damage the head's mirror-smooth finish, it may change the magnetic characteristics of the heads, causing a deterioration in reproduction performance quality.

9. Although the record/playback head used in this unit is a high quality Amorphous head with outstanding reproduction characteristics, it can become dirty through the use of old tapes of from dust accumulation over time. This can have a serious effect on reproduction quality. Clean the heads regularly with one of the commonly available head cleaners or with cleaning solutions as explained later in this manual.

10. Be sure to read the "Troubleshooting" section of this manual for advice on common operating errors before concluding that your unit is faulty.

11. Keep this manual in a safe place for future reference.

12. Voltage Selector (General Model only)
The voltage selector on the rear panel of this unit must be set for your local mains voltage BEFORE plugging in the AC mains supply. Voltage are 110/120/220/240V AC, 50/60 Hz.

CAUTION FOR CANADA MODEL
TO PREVENT ELECTRIC SHOCK DO NOT USE THIS (POLARIZED) PLUG WITH AN EXTENSION CORD, RECEPTACLE OR OTHER OUTLET UNLESS THE BLADES CAN BE FULLY INSERTED TO PREVENT BLADE EXPOSURE.

FEATURES

- Amorphous Rec/Play Heads — Sophisticated amorphous heads with superior magnetic characteristics for high quality playback and recording.
- Dolby HX Pro Dynamic Bias Servo — This unique system from Dolby Laboratories greatly enhances the quality of cassette recording by effectively extending the available tape headroom. Thus expanding the available dynamic range, particularly in the high frequency range.
- Dolby B and C Noise Reductions — The widely used Dolby noise reduction systems are extremely effective in reducing undesired tape hiss.
- MPX Filter — This filter is useful for removing the undesired 19 kHz pilot signal while recording FM broadcasts.
- Intro Scan — This unique feature allows the sample playback of the beginning of selections on a cassette.
- Play Trim — A newly designed circuit which increases the compatibility and sound quality of recordings made on other cassette decks.
- Fine Bias Adjustment — For accurate reproduction the function lets you make the critical bias adjustment.
- Full and Phrase Repeat Functions — These feature are convenient for repeated playback (8 times) of any part of a cassette; from a complete tape side all the way down to a 3 second portion.
- Timer Ready — For unattended recording and playback, the KX-300/U is compatible with most commercially available timers.
- Auto Tape Selector — Built in sensors automatically determine the type of tape loaded and internally adjust critical factors such as equalization and bias.
- 10-key Wireless Remote Control supplied with KX-300/U or an amplifier or receiver bearing the RS mark — Lets you control the main functions of the KX-300/U from anywhere in the room.

FRONT PANEL PARTS AND FUNCTIONS

(See Fig. 1.)

① POWER switch

Press this switch to turn the power ON and OFF.

② Cassette compartment door

Insert a cassette with its exposed side down and the side to be played facing you.

③ TAPE COUNTER and RESET button

Use this counter as an aid in locating a point on a tape. To reset the counter reading to "000" press the RESET button.

④ REMOTE CONTROL sensor

Receives signals from the remote control transmitter.

⑤ Indicator Display

① PEAK signal level meters

These indicate the peak of the signal levels during recording and playback over a range from -20 dB to +6 dB. Each LEFT and RIGHT channel has its own meter.

② REC indicator

This indicator will light up during the Record Rec/Pause modes. During Auto Rec Mute mode, it will blink.

③ Noise reduction indicators

The B TYPE or C TYPE indicator lights when either when its corresponding noise reduction is selected.

④ TAPE type indicators

When a tape is loaded, the deck's sensors will automatically determine what type of tape is loaded and light the corresponding indicator.

- Automatic tape selection does not function for the early model Metal type tapes which do not have the necessary detector slots. (See Fig. 11.)
- The KX-300/U deck is not designed for use with Ferrichrome (III/FeCr) tapes.

⑥ REC controls

REC LEVEL: This control is used to adjust and set the recording level. Turning it clockwise increases the recording level, and turning it counterclockwise decreases the recording level.

BALANCE: This control is used to balance the recording levels of the left and right channels. Turning it clockwise decreases the left channel's recording level. While turning the control counterclockwise decreases the right channel's recording level. Normally, adjust this control so that left and right recording level indicators peak to the same reading.

⑦ DOLBY NR selector

OFF:

Set to this position if no noise reduction is desired.

In the OFF position, signals do not pass through the noise reduction circuits and are output unprocessed.

B and C TYPE:

When playing tapes encoded with Dolby NR or making recordings (of sources except FM. If FM, see MPX ON and OFF) to be encoded with Dolby NR, set the selector to the desired type of Dolby noise reduction; B or C TYPE MPX OFF.

- Dolby noise reduction is an extremely effective method of reducing undesirable background hiss on tapes. This unit incorporates both Dolby B NR and the newer Dolby C NR systems. Dolby C NR is approximately twice as effective as Dolby B NR. (See page 14.)
- When playing back any tape (even a recording of an FM broadcast) encoded with Dolby B or Dolby C, set the selector to the B TYPE MPX OFF or C TYPE MPX OFF, respectively.

- Dolby and the double D mark are trademarks of Dolby Laboratories Licensing Corp. Dolby noise reduction system manufactured under license from Dolby Laboratories Licensing Corp.

MPX filter ON and OFF:

When recording from FM stations, set the selector to the Dolby NR desired and also set it to the B or C TYPE MPX ON position. However, when not recording FM broadcasts but using Dolby NR, set the selector to the B or C TYPE MPX OFF position.

- FM stations transmit a 19 kHz pilot signal in addition to the broadcast program. Sometimes this pilot signal may leak into the audio output depending on the tuner and broadcast conditions. Since the 19 kHz pilot signal is undesirable, activating the MPX filter will effectively filter out the signal.

⑧ AUTO MODE selector

OFF:

For normal playback or recording, set to this position.

REPEAT FULL:

During or before engaging the Play mode, set the AUTO MODE selector to REPEAT FULL. The one side of the cassette is repeatedly played back 8 times from beginning to end.

REPEAT PHRASE:

During or before engaging the Play mode, set the AUTO MODE selector to REPEAT PHRASE. A phrase (section) of the loaded tape can be repeatedly played back 8 times. The length of the phrase can range from 3 seconds all the way up to the total playing time of one cassette side.

TIMER PLAY:

By using a commercially available audio timer, this function permits timer activated playback.

TIMER REC:

By using a commercially available audio timer, this function allows you to carry out unattended recording.

- Be sure to set this selector to OFF when not using the repeat or timer features. If power is accidentally turned on with a cassette loaded in the deck and the selector in the TIMER REC position, the Record mode will be engaged and the recorded contents of the tape will be erased.

⑨ PLAY TRIM control (See Fig. 6.)

PLAY TRIM is a newly developed feature which functions to increase the compatibility between the KX-300/U and tapes recorded on another deck.

During playback, turn the PLAY TRIM control knob to the position which offers the best sound quality. This setting is based on personal preference.

⑩ BIAS ADJUST control

This control is provided to adjust the recording bias to its optimum value according to the type of every brand of tape used. (Refer to "BIAS ADJUSTMENT" on page 15).

⑪ Main operation buttons

◀◀: Fast Rewind button. Press this button to rapidly rewind the tape.

This button is also used to specify the end of the section for the Repeat Phrase mode. To stop fast rewinding press the STOP button.

▶▶: Fast Forward button. Press this button to rapidly advance the tape. To stop fast forwarding, press the STOP button.

▶▶: Fast Forward button. Press this button to rapidly advance the tape. To stop fast forwarding, press the STOP button.

REC/PAUSE: Pressing this button engages the Rec/Pause mode, and the REC indicator will light. While in this mode, the PEAK level meters will function, allowing you to monitor and set the recording signal level of your program source. (Refer to the "SETTING RECORDING LEVEL" section on page 20) To initiate recording from the Rec/Pause mode, press the PLAY button. Pressing the REC/PAUSE button during actual recording engages the Rec/Pause mode once again.

STOP: Press this button to stop the tape while in any mode.

MUTE/SEARCH:

● During Recording:

When the MUTE/SEARCH button is pressed at any time during recording, a 4-second blank interval is automatically recorded onto the tape (Auto Rec Mute mode), then the Rec/Pause mode is engaged immediately thereafter.

In order to record a blank interval longer than 4 seconds, press the MUTE/SEARCH button and hold it down for the desired length of time. After the button is released, the additional 4-second blank interval will also be recorded, then the Rec/Pause mode is engaged immediately thereafter.

* When the MUTE function is operating, the REC indicator lights on and off.

● During Playback:

By pressing the ▶▶ button simultaneously with MUTE/SEARCH button, the tape will advance to the beginning of the next section and begin play.

By pressing the ◀◀ button simultaneously with MUTE/SEARCH button, the tape will rewind to the beginning of the current section and begin play.

⑫ INTRO SCAN ◀ and ▶ keys

Press one of these keys to play back the approximately first 15 seconds of each selection in the desired direction. Once the desired selection is found, press the PLAY button to defeat the Intro Scan mode and engage the Play mode.

REMOTE CONTROL TRANSMITTER**13 PHONES jack**

Connect headphones to this jack for monitoring a recording or playback.

14 EJECT button

To open the cassette compartment door press the EJECT button and the cassette door will open. Insert a cassette tape, tape side down, into the holder on the inside of the door. To close the cassette compartment, push the door shut until it locks in the closed position.

(See Fig. 2.)

1 INTRO SCAN ◀ and ▶ keys

This function of these keys is identical to the INTRO SCAN buttons on the deck.

2 SEARCH ◀◀ and ▶▶ keys

These keys function the same as simultaneously pressing the MUTE/SEARCH and ◀◀ or ▶▶ buttons on the deck. These keys can be used while in the Stop or Play mode.

◀◀: By pressing this key, the tape will rewind to the beginning of the current selection and, at which point, play will begin.

▶▶: By pressing this key, the tape will advance to the beginning of the next selection and play will begin.

3 Main operation keys

These keys have the same function as their counterparts on the deck. The one difference is the REC MUTE key of the remote control: it controls only the MUTE function of the MUTE/SEARCH button of the deck since the search function is already controlled by the SEARCH keys on the remote control.

■ BATTERY INSTALLATION (See Fig. 3.)

- ① Slide out the battery compartment lid in the direction of the arrow.
- ② Install the batteries (size "AA", R06) with correct polarities. Follow the diagram in the compartment.
- ③ Installation of the battery compartment lid is the reverse of removal. Slide the lid until it clicks securely in place.

■ REMOTE CONTROL OPERATION RANGE (See Fig. 4.)

The remote control transmitter uses harmless infrared light to control the KX-300/U. Therefore, to function properly there must be a clear, unobstructed path between the transmitter and the sensor on the deck.

■ BATTERY REPLACEMENT

When the operating distance of the remote control noticeably decreases, the batteries are exhausted. Immediately replace the batteries with new ones.

- Replace old batteries with fresh ones. Do not use an old battery together with new one.
- Install the same of batteries at the same time. So not use different kinds of batteries (carbon, alkaline, Ni-Cad, etc.) at the same time even though they are the same shape.
- There are two kinds of batteries in the market: rechargeable and non-rechargeable. Read the caution labels on the battery carefully.

■ BATTERY SAFETY

Incorrect use of the battery can cause leakage or explosion. Proper handling and use of batteries is as follows:

- When the remote control will not be used for an extended period of time, remove the batteries.
- Never disassemble, heat or throw a battery into a fire.
- Do not connect (short circuit) the (+) and (-) battery. In case of leakage, thoroughly wipe off all the electrolyte from the battery compartment and install new batteries.

■ DOLBY NOISE REDUCTION (See Fig. 5.)

With cassette tapes, the most noticeable form of noise is high frequency hiss. To reduce this hiss noise, the KX-300/U is equipped with the older Dolby B noise reduction system in addition to the newer Dolby C NR. Either type of noise reduction may be selected with the DOLBY NR selector.

The older Dolby B system is still very handy when playing back that extensive library of Dolby B encoded tapes as well as recording tapes that will be played back on a system which offers only this kind of noise reduction system (some car, portable, and older cassette decks). Dolby B NR has a noise reduction effect of about 10 dB in the high frequency range. The corresponding effect with Dolby C NR is about 20 dB, but this is over the entire range where the human ear is most sensitive to noise (2 kHz to 8 kHz). Dolby C NR also improves the tape's MOL (Maximum Output Level).

Dolby C NR has two new circuits: a spectral skewing circuit and an anti-saturation network. By improving the saturation level of the tape it is possible to prevent high frequency loss, encode/decode error, etc., and improve dynamic range, signal-to-noise ratio, and make it easier to set the recording level.

With Dolby C NR it is possible to achieve the same noise reduction effect at both high and low signal levels and to set the recording level to a point where negative side effects are eliminated. Also, by expanding the operating frequency range to two octaves more than that of Dolby B NR, overall noise balance is obtained and the system also becomes effective against high frequencies from the power supply transformer.

The graph shows the frequency response and the noise reduction effect of recording and playback with Dolby B NR and Dolby C NR. The noise reduction effect of Dolby C NR is larger — approximately 20 dB.

Dolby noise reduction is a 2 part process that acts both on recording and playback; be sure that the DOLBY NR switch is set to the same position during record and play.

- * Tapes encoded with Dolby NR should be decoded with their respective systems. Nevertheless, a Dolby encoded tape can be played back without decoding (and vice versa) with no harm to the recording.
- * Noise in the source material cannot be reduced with the Dolby NR system.

■ HX-PRO DYNAMIC BIAS SERVO SYSTEM (See Fig. 8.)

When recording, a bias current according to the tape type used is applied to the recording head as well as the music signal to improve the distortion rate. Furthermore, the extreme high frequency content of a music signal can actually act as bias, adding to the deck's own bias signal to produce over-bias conditions. The result is the deterioration of the high frequency components of the music signal.

To remedy this, the Dolby HX-Pro system monitors the total amount of effective bias during recording, and instantaneously compensates for any excess bias by reducing the level deck's bias signal accordingly. The deck operates independently on each channel.

Since HX-Pro is not a noise reduction system because it functions only in recording and no decoding is required, a tape recorded with the HX-Pro system can be played back on any other cassette deck while retaining the benefits of HX-Pro.

Dolby Noise reduction and HX-Pro headroom extension are manufactured under license from Dolby Laboratories Licensing Corporation. HX-Pro was originally developed by Bang & Olufsen. "DOLBY", the double-D symbol  and "HX PRO" are trademarks of Dolby Laboratories Licensing Corporation.

■ PLAY TRIM (See Fig. 6.)

Tapes recorded on one deck can be played back on another. However, slight differences occur between any two decks such as playback frequency response and head azimuth. To solve this problem, this unit incorporates a newly-designed PLAY TRIM control.

Fig. ① shows the frequency response curve for recording and playback on this deck. The PLAY TRIM circuit makes it possible to control the playback frequency response by approximately ± 3.5 dB at 10 kHz.

Fig. ③ shows the frequency response curve for playback on this deck of a tape recorded on a deck with Dolby NR ON. When Dolby C is ON, the response compensation can extend up to more than ± 10 dB. The figure shows a drop of 10 dB in the frequency response at 10 kHz.

However, in some cases, the high frequency response is emphasized. By adjusting the PLAY TRIM control, music tapes recorded on other decks can be played back without high frequency degradation.

Fig. ② shows the frequency response curve for playback on this deck of a tape recorded on a deck with Dolby NR OFF. The figure shows a drop in the high frequency response at 10 kHz. But in some cases, the high frequency response is emphasized.

The PLAY TRIM control is similar to the treble tone control of an amplifier, and is characterized by the fact that it can be controlled even when Dolby NR is ON, because it functions between the playback equalizer and the Dolby NR decoder circuits.

During playback, turn the PLAY TRIM control to the position which offers the most agreeable sound quality.

CONNECTIONS

■ BIAS ADJUSTMENT (See Fig. 7.)

This control is for fine adjustment of the recording bias. Normally it is not necessary to adjust this control since the deck's Auto Tape Selector automatically adjusts the recording bias for different tape types.

Nevertheless, the deck cannot adjust for the wide range of personal preferences not for every brand of tape on the market (bias requirements can vary from brand to brand). Should you feel that your recording needs further bias adjusting (absent or distorted high frequencies), refer to Fig. 7 and adjust this control to your tastes.

Turning the control counterclockwise decreases the bias and will result in recordings with boosted high frequencies (treble). Too little bias can result in too much high frequency or distorted mid-low frequency. If distortion is more important than high frequencies, turn the control clockwise to increase the bias signal.

■ REAR PANEL CONNECTIONS (See Fig. 9.)

Make sure that power to both the KX-300/U and your amplifier/receiver are turned off before making any connection.

The White plug on the paired connecting cables corresponds to the Left channel and the Red plug corresponds to the Right channel. The LINE OUT/PLAY jacks on the KX-300/U should be connected to the Tape PB (Playback/Input) jacks on your amplifier/receiver, and the LINE IN/REC jacks on the KX-300/U should be connected to the Rec Out (Rec/Output) jacks on your amplifier/receiver.

Make sure that the left and right channel connections are properly made, and that the plugs are inserted firmly.

Connect the power cord to an AC wall outlet or to an AC outlet on the rear panel of your amplifier/receiver (if provided).

CASSETTE TAPES

■ CASSETTE TAPES

There are many different types of cassette tapes available, however, they all conform to standard specifications so any brand may be used with the KX-300/U.

- Classification of Cassettes Tapes by Formulation
Cassette tapes are available in four basic types depending on their formulation, or type of magnetic material and manufacturing process. These four types are commonly known as Normal (Type I/NORM), Chrome (Type II/CrO₂), Ferrichrome (Type III/FeCr), and Metal (Type IV/METAL), and they each require specific tape deck adjustments for optimum performance.

■ AUTO TAPE SELECTOR DETECTION SLOTS

The KX-300/U has a built-in Auto Tape Selector which automatically adjusts for the proper bias, level and equalization according to the tape formulation — all you have to do is load a cassette and the Auto Tape Selector does the rest.

The Auto Tape Selector determines what type of tape is loaded by sensing detector slots in the top of a tape shell (See Fig. 11.). Each tape formulation has its own characteristic hole markings which has been standardized by the tape industry.

- Early model Metal (Type IV/METAL) tape formulation cassette shells do not have the slots for Auto Tape Selector operation. As a result, early model Metal type tapes recorded on another deck will be played back with the KX-300/U at the Chrome (Type II/CrO₂) settings. YAMAHA does not recommend recording with this kind of tape on the KX-300/U.

- The KX-300/U does not have the required setting for Ferrichrome (Type III/FeCr) tape, since this tape formulation is not widely used. Should you use a Ferrichrome tape, it will be recorded and played back at the Normal (Type I/NORM) settings. And this will result in an unnatural high frequency emphasis. This effect may be compensated for somewhat by adjusting the BIAS ADJUST to the plus (+) direction during recording, or by using the PLAY TRIM control and/or the tone controls of your amplifier during playback.
- * YAMAHA does not recommended the use of 120 minute length cassettes since the extreme thinness of the tape makes them susceptible to mechanical and recording problems.

■ PROTECTING YOUR RECORDINGS (See Fig. 10.)

All cassette tapes are provided with erasure protection holes to prevent accidental erasure of recorded contents. There is a small tab covering the hole on each cassette, and it should be broken off after recording a tape. Without this tab covering the hole, it is impossible to record onto that tape. Thus, you can safely protect a recording for as long as you wish without fear of accidental erasure. Should you wish to use a cassette tape protected in this way for recording, simply covering the hole with adhesive tape will permit erasure and re-recording.

- * When using Chrome (Type II/CrO₂) or Metal (Type IV/METAL) tapes, make sure you do not cover the hole intended for the Auto Tape Selector operation.

OPERATION

■ TAKING UP SLACK IN THE TAPE (See Fig. 12 .)

As a precaution against tape entanglement and damage, before inserting cassettes into the KX-300/U, remove any slack in the tape. This is accomplished by inserting a pencil, pen or similar object into one of the spools and gently winding it until all the slack is removed. You do not have to wind it too tightly.

Be careful not to touch the tape part itself. It is very delicate and touching it may damage the tape and its recorded contents.

■ STORING CASSETTES

After putting a cassette tape back into its case, store in a location away from exposure to direct sunlight, humidity, high temperatures, and magnetic fields (away from television sets, speakers, etc.). High temperatures and humidity will damage the tape itself, while exposure to magnetic fields may cause a loss of recorded material. Avoid touching the tape surface with your fingers, since dirt or finger oil will contaminate the heads.

PLAYBACK OF A CASSETTE

1. Press the EJECT button to open the cassette compartment door.
2. Insert a pre-recorded cassette, tape-side-down, into the lid's tape holder. Close the cassette compartment door.
3. Position the DOLBY NR selector accordingly.
4. Operate any of the main operation buttons if necessary.
5. Press the PLAY button to start playback.
6. Adjust the PLAY TRIM control as desired.
7. To stop playback, press the STOP button.

■ FULL REPEAT

The one side of the tape is repeatedly played back 8 times.

1. Set the AUTO MODE selector to FULL REPEAT.
2. Press the PLAY button. The one side will be repeatedly played 8 times.
or
Press the ◀◀ fast rewind button. As soon as the tape is completely rewound playback will begin. The one side will be repeatedly played 8 times.

■ PHRASE REPEAT

With this function a desired section of the tape can be repeatedly played back 8 times.

1. Set the AUTO MODE SELECTOR to PHRASE REPEAT.
2. Start playback.
3. The beginning point of the phrase will be wherever the PLAY button was last pressed.

4. To specify the end of the phrase, while the tape is playing, press the ◀◀ button. The tape will rewind back to the beginning point and begin play again.
5. The phrase will be played 8 times. Play will then stop.
 - A phrase must be at least 3 seconds long.
 - Pressing the PLAY button during Phrase Repeat, defeats the Phrase Repeat function and specifies a new phrase beginning point.

■ INTRO SCAN

During playback or while in Stop mode, press either of the INTRO buttons. The beginning of each selection is played back for about 15 seconds in the selected direction. Once a desired selection is located, press the PLAY button while the beginning of the desired selection is being played back to set the unit to normal Play mode.

■ FOR TROUBLE-FREE OPERATION FOR BLANK SEARCH FUNCTION

Scan and search functions operate by searching the tape for a noise-free, blank section. To ensure error-free operation, please follow these precautions:

- Use a tape that is free from noise or previously recorded music in the blank portions between selections.
- Do not use tapes that include selections with long silences or low level passages.
- The blank section must be at least 4 seconds long.

RECORDING

1. With a recording tape in the cassette compartment, press the REC/PAUSE button.
2. Play the source to be recorded. The Tape deck engages the Rec/Pause mode and activates the signal level meters. To avoid tape saturation, it is best to play the loudest passage of the source and to set the recording level based on that passage.
3. Refer to "SETTING THE RECORDING LEVEL" section, and determine the maximum recommended recording level.
4. Observe the peak readings of the LED signal meters (read the numbers adjacent to the meters) and turn the REC LEVEL control to the point such that the meter's indicators light up to but not beyond the maximum recommended recording level. You may also adjust the BALANCE control to make the left and right meter readings even.
5. Reset the source to be recorded back to its beginning.
6. Press the KX-300/U's PLAY button to start recording and then start play of the source.
7. To temporarily stop recording, press the PAUSE/REC button. The deck will engage the Pause/Rec mode. To start recording again, press the PLAY button.
8. When the ◀◀ button is pressed during recording, the tape will be rewound to the point where recording began. This feature is very useful for canceling a recording.
9. To fully stop the recording, press the STOP button.

NOTE:

Please check the copyright laws in your country to record from records, compact discs, radio, etc. Recording of copyrighted material may infringe copyright laws.

■ SETTING THE RECORDING LEVEL

Proper setting of the recording level is crucial in making a quality recording. If the recording level is set too high, the recording will sound distorted and muffled. If the recording level is set too low, the full recording capabilities of the tape will not be reached and the recording will sound faint and too quiet. The key in making a good recording is, therefore, to adjust the recording level as high as possible while still avoiding distortion.

Press the REC/PAUSE button to engage the Rec Standby mode, and play a section of the program to be recorded. Watch the PEAK level meters and adjust the REC LEVEL control so that the average meter reading is between -6 dB and +3 dB, with occasional peaks no higher than +6 dB.

■ MUTE

When the MUTE/SEARCH button is pressed during actual recording, a blank 4-second interval is automatically recorded on to the tape, and then the Rec/Pause mode is engaged. This is handy for placing blank spaces necessary for proper operation of the Search and Intro Scan features.

TIMER RECORDING/PLAYBACK (See Fig. 18.)

When using the AUTO MODE selector's TIMER REC or PLAY functions in combination with a commercially available audio timer, it is possible to make recordings and initiate playback at any time automatically.

● Timer Recording

1. Make sure that all power cord connections between the timer and amplifier are properly made. No change in any of the other connections between deck and amplifier, etc., are necessary.
 2. After turning on the power to each component, select the station on your tuner which you want to record and turn down the volume on your amplifier. This will have no effect on the recording signal level. Remember to set the proper recording level.
 3. Set the timer to the desired times. It is advisable to set the timer to begin recording slightly before and end slightly after the actual broadcast recording time, so that you leave some room for later editing.
 4. Set the AUTO MODE selector to the TIMER REC position.
 5. The timer will send power to the amplifier, tuner and deck at the preset time, turning all the components on and initiating the recording mode.
- Be sure to set this selector to OFF when not using the repeat or timer features. If power is accidentally turned on with a cassette loaded in the deck and the selector in the TIMER REC position, the Record mode will be engaged and the recorded contents of the tape will be erased.

NOTE:

If the tape cannot be ejected after timer recording, turn the AUTO MODE selector OFF and the KX-300/U's POWER switch ON. The tape can then be ejected.

● Timer Playback

1. All connections are the same as for timer recording.
2. Turn on the amplifier and adjust the Volume and Tone controls.
3. Set the input mode selector of your amplifier to the Tape mode.
4. Set the timer to the time you wish to start and stop playback.
5. Set the AUTO MODE selector to the TIMER PLAY position.
6. At the preset time, the timer will turn power on to the amplifier and tape deck and begin playback. It will shut power OFF, at the preset time as well ending playback.

MAINTENANCE

■ CLEANING OF TAPE PATH

The continued high quality performance of your KX-300/U is dependent upon regular periodic cleaning of the heads, capstan, pinch roller, and all surfaces over which the tape travels. Normal use will see an accumulation of dirt and dust on the heads, capstans, and pinch rollers. This can lead to poor sound quality, drop outs (intervals with no sound), unsteady tape speed, loss of high frequency response, etc. We recommend commercially available cassettefluid type cleaners.

■ DEMAGNETIZATION

After 20-30 hours of use, enough residual magnetism will have built up on the heads to cause poor high frequency reproduction. At this time you should use a commercially available head demagnetizer.

- When demagnetizing the heads, be sure to follow the instructions of the head demagnetizer carefully.

■ CLEANING THE CABINET

Clean the cabinet with a soft cloth lightly moistened with a mild detergent. Never use solvents such as benzine, acetone, alcohol, etc. for they may damage the KX-300/U's finish.

TROUBLESHOOTING

When your KX-300/U cassette deck fails to function properly, before assuming it is faulty, check the following troubleshooting list. It details common operating errors and the corrective action you can take yourself without having to call a service engineer. If you have any doubt or questions, consult your nearest YAMAHA dealer or service center.

Problem	Cause	Cure
Tape does not move in recording or playback	<ul style="list-style-type: none"> ● Power plug not properly plugged in. ● End of tape. 	<ul style="list-style-type: none"> ● Reinsert plug properly. ● Rewind tape or flip it over.
Sound is faint and sometimes inaudible.	<ul style="list-style-type: none"> ● Head is dirty. ● Head is magnetized. ● Tape transport section dirty. 	<ul style="list-style-type: none"> ● Clean head using cleaning tape. ● Demagnetize head using head demagnetizer. ● Change to different tape.
Tape speed is uneven.	<ul style="list-style-type: none"> ● Tape is bad (stretched or deformed, etc.). ● Cassette shell is warped. 	<ul style="list-style-type: none"> ● Replace with a fresh tape. ● A warped cassette tape should be replaced with another tape and tested.
Recorded sounds are distorted.	<ul style="list-style-type: none"> ● Recording level is too high. 	<ul style="list-style-type: none"> ● Check input level with meter and use a lower recording level when recording.
Tape is playing back, but no sound is heard.	<ul style="list-style-type: none"> ● Faulty connection between deck and stereo amplifier. 	<ul style="list-style-type: none"> ● Turn off all power and check connections.
Excessive noise.	<ul style="list-style-type: none"> ● Head is dirty. ● Head is magnetized. ● Worn out or poor quality tape. ● Connection(s) improperly made. ● Affected by external electrical interference. 	<ul style="list-style-type: none"> ● Clean head. ● Demagnetize head with head demagnetizer. ● Change to higher quality tape. ● Check input and output connections and reinsert properly. ● Move away from electrical appliances (TV, fluorescent light, electric blanket, etc.)
Tape stops in the middle of recording or playback.	<ul style="list-style-type: none"> ● Slack tape, or tape entanglement around capstan. ● Warped cassette shell causing too much friction. 	<ul style="list-style-type: none"> ● Insert pencil in hole in cassette shell and wind up any slack. ● Do not use warped cassettes.
Intro Scan or Search does not operate.	<ul style="list-style-type: none"> ● Recorded section is too short. ● Recorded section has low-level passages. ● Conversation, etc. has been recorded. 	<ul style="list-style-type: none"> ● Blank sections must be at least 4 seconds long.

Problem	Cause	Cure
High frequencies in the playback sound are emphasized and unpleasant to listen to, and noise level (hiss) is also high.	<ul style="list-style-type: none"> ● Dolby-recorded tape is played back in OFF position. 	<ul style="list-style-type: none"> ● Playback in appropriate Dolby position.
Playback sound is muffled and high frequencies are inaudible.	<ul style="list-style-type: none"> ● Normally-recorded tape is played back with Dolby NR. ● Heads are dirty. ● Heads are magnetized. 	<ul style="list-style-type: none"> ● Playback in DOLBY NR OFF position. ● Clean heads and carry out demagnetization with head demagnetizer.
When playing back tapes recorded on other decks, meter deflections are greater (smaller) than when recording.	<ul style="list-style-type: none"> ● Basic levels are different for different cassette decks. 	<ul style="list-style-type: none"> ● This is not a malfunction.
Fails to record.	<ul style="list-style-type: none"> ● PRESET REC LEVEL controls too low. ● Protective tabs broken off. 	<ul style="list-style-type: none"> ● Adjust PRESET REC LEVEL controls. ● Change tape or cover protective hole with cellophane tape.
REC/PAUSE button fails to function.	<ul style="list-style-type: none"> ● No cassette tape loaded. ● Protective tab broken off. 	<ul style="list-style-type: none"> ● Load a cassette tape. ● Use a blank tape, or cover the recording protection hole with cellophane tape.
Recordings cannot be made with TIMER REC (deck only plays back).	<ul style="list-style-type: none"> ● Protective accidental erasure tabs on cassette have been broken off. 	<ul style="list-style-type: none"> ● Replace cassette tape, or cover tab holes with tape, etc.

SPECIFICATIONS

Track Configuration	4 track, 2 channel stereo
Motor	DC servo motor (capstan) Flat torque DC motor (reel)
Heads	Recording/playback: Amorphous Erase: Double Gap Ferrite
Rapid Transport	
(F.Fwd/Rew)	90 sec. (C-60)
Wow and Flutter	
WRMS	less than 0.05%
W.Peak	less than $\pm 0.08\%$
Signal-to-Noise Ratio	
(Off)	better than 60 dB
(Dolby B on)	better than 68 dB
(Dolby C on)	better than 76 dB
Frequency response	
Normal tape (-20 dB)	30 — 17,000 Hz ± 3 dB
Cr₂ tape (-20 dB)	30 — 19,000 Hz ± 3 dB
Metal tape (-20 dB)	30 — 20,000 Hz ± 3 dB
Harmonic Distortion (315 Hz, 3rd)	No more than 1%
Input Sensitivity/Impedance	
Line	50 mV/50 k-ohms
Output Level	
Line	360 mV/1 k-ohm
Phones	0.3 mW/8 ohms
Channel Separation (3150 Hz)	40 dB
Cross Talk (125 Hz)	55 dB

GENERAL

Power Supplies

U.S.A. and Canada models 120 V, 60 Hz

British and Australian models 240 V, 50 Hz

Other Areas 110/120/220/240 V, 50/60 Hz

Power Consumption

..... 18 W

Dimensions (W x H x D)

..... 435 x 112 x 273 mm

(17-1/8" x 4-7/16" x 10-3/4")

Weight

..... 4.2 kg (9 lbs. 4 oz.)

* Specifications subject to change without notice.

YAMAHA
HAMAMATSU, JAPAN

VE64580-0

YAMAHA CORPORATION
BWgV, BR  Printed in Japan.